

## Ficha técnica

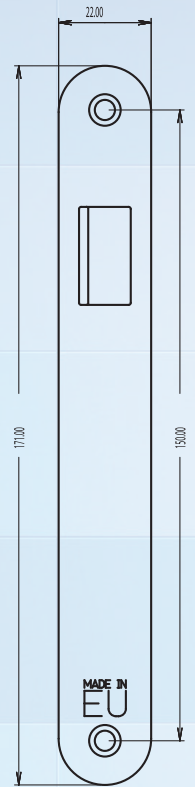
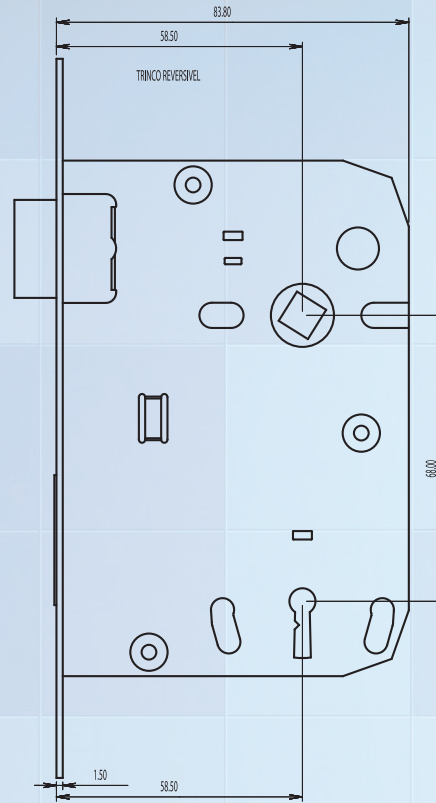
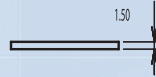
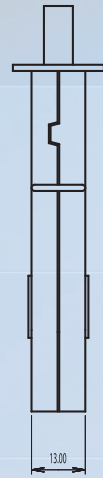

### Fechadura Magnética com Chave

Cor	Preço
Inox Mate	6,42€
Inox Lacado	6,66€
Latão Bronze	7,52€
Latão Polido	7,60€

## Ficha técnica

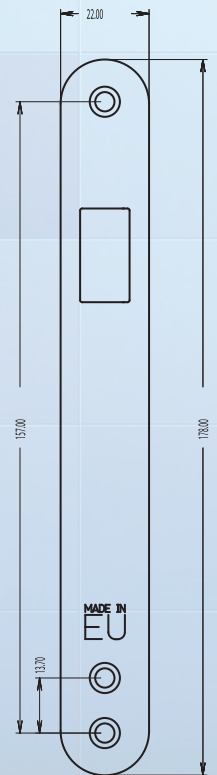
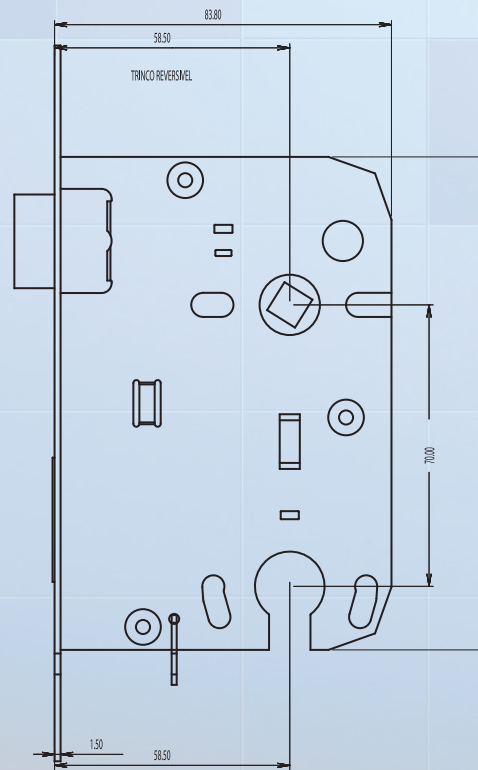
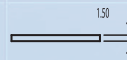
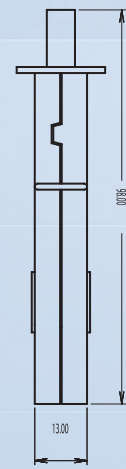

### Fechadura Magnética com Entrada Yall

Cor	Preço
Inox Mate	6,42€
Inox Lacado	6,66€
Latão Bronze	7,52€
Latão Polido	7,60€



## Ficha técnica

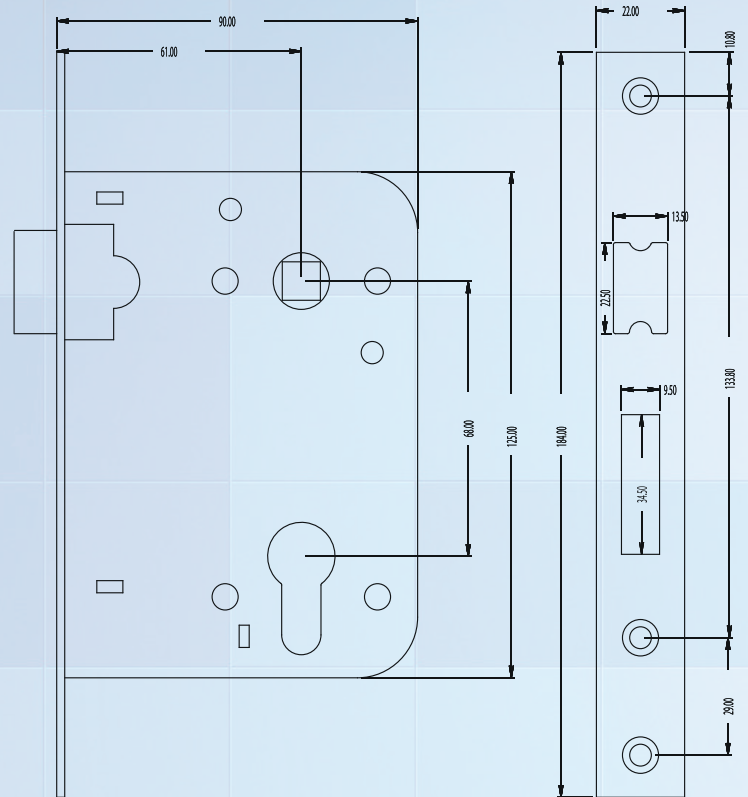
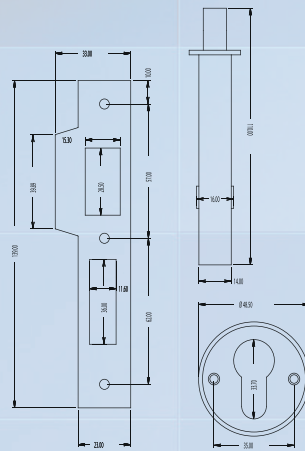

## Fechadura

Ref. 725

Tamanhos: 60

Cor	Preço
Inox Mate	7,72€
Latão Bronze	9,20€
Latão Polido	9,48€
Ferro / Bronze	7,54€
Ferro Lacado	8,02€

## Fechadura

Ref. 725

Tamanhos: 40/45/50/55/65  
70/75/80/85

Cor	Preço
Inox Mate	7,92€
Latão Bronze	9,22€
Latão Polido	9,60€
Ferro / Bronze	7,74€
Ferro Lacado	8,24€



## Ficha técnica

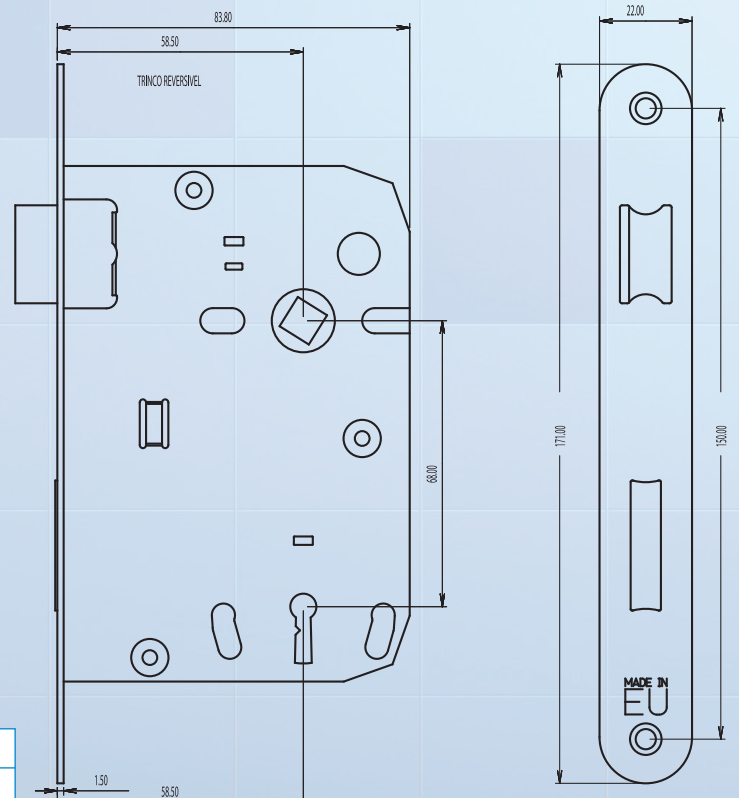
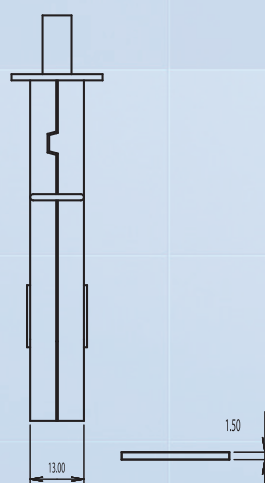

## Fechadura

Ref. 716

Testa Quadrada / Redonda

Tamanhos: 60

Cor	Preço
Inox Mate	3,10€
Inox Polido	3,20€
Latão Bronze	4,20€
Latão Polido	4,39€
Ferro / Bronze	2,88€
Ferro Lacado	3,32€
Latonado	3,58€

## Fechadura

Ref. 716

Testa Redonda / Quadrada

Tamanho: 40/45/50/55/65

Cor	Preço
Inox Mate	3,30€
Inox Polido	3,45€
Latão Bronze	4,44€
Latão Polido	4,59€
Ferro / Bronze	3,03€
Ferro Lacado	3,48€
Latonado	3,73€



## Ficha técnica

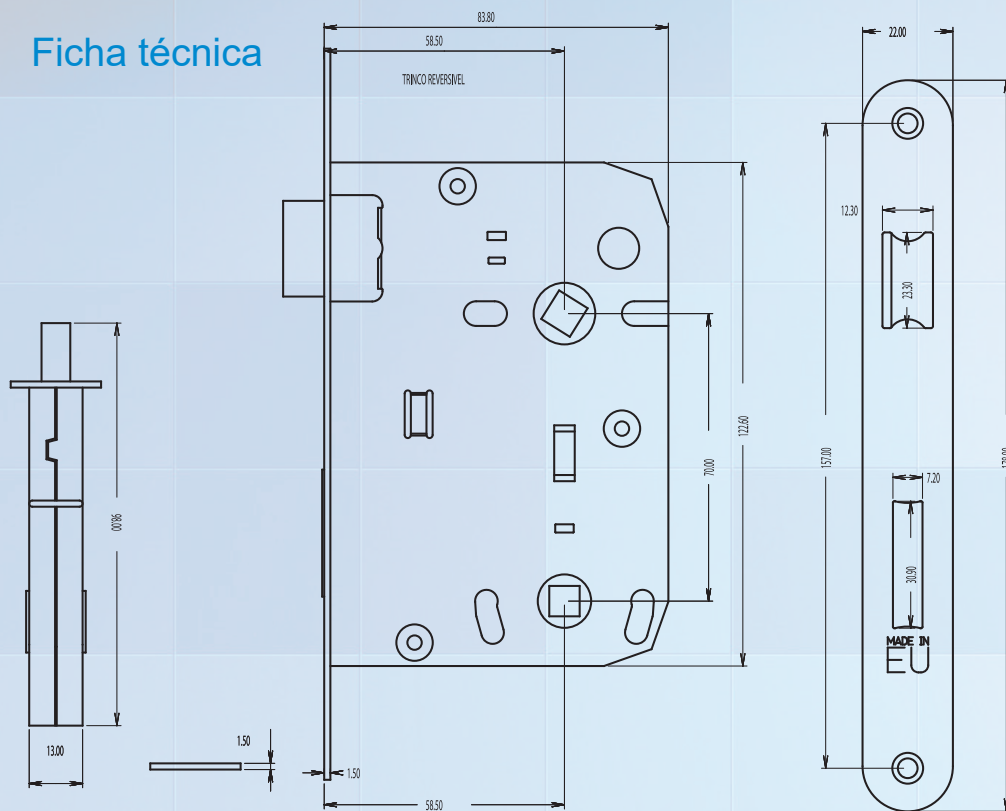

### Fechadura "2 Zarehos"

Ref. 716

Testa Quadrada / Redonda

Tamanho: 60

Cor	Preço
Inox Mate	3,69€
Latão Bronze	4,50€
Ferro Polido	4,65€
Ferro Lacado	3,73€



## Ficha técnica

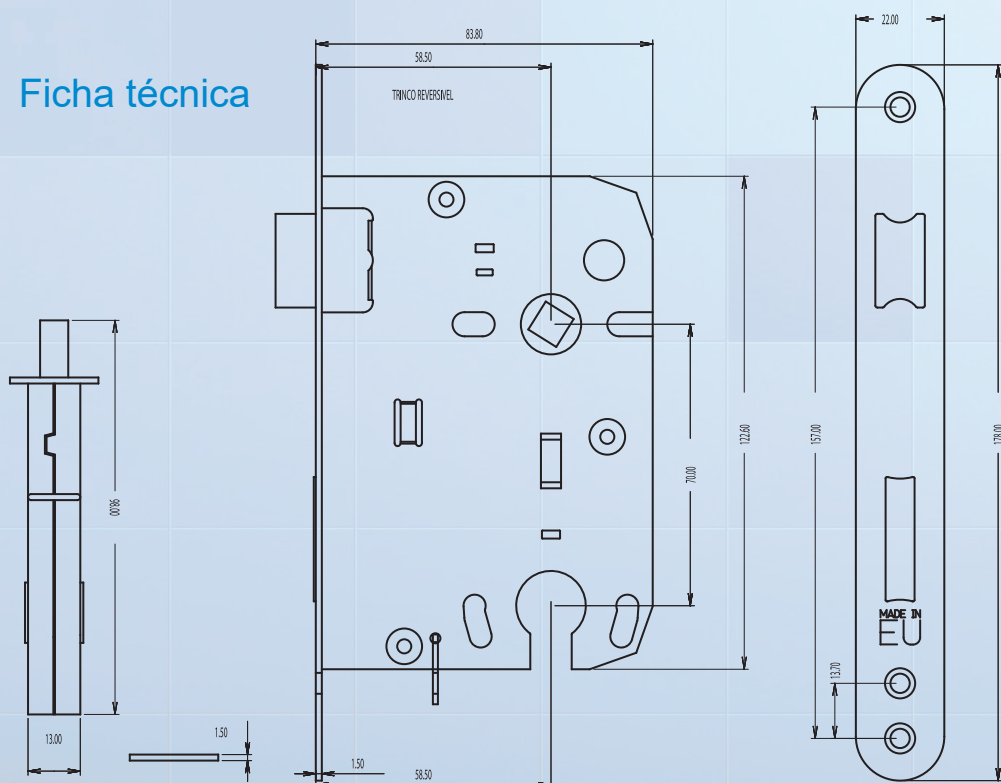

### Fechadura Económica

Ref. 716 / 725

Testa Quadrada / Redonda

Tamanho: 60

Cor	Preço S/Entradas YALL	Preço C/Entradas YALL
Inox Mate	3,50€	4,08€
Latão Bronze	4,53€	5,45€
Latão Polido	4,63€	6,02€
Ferro / Bronze	3,35€	3,99€
Ferro Lacado	3,75€	4,37€

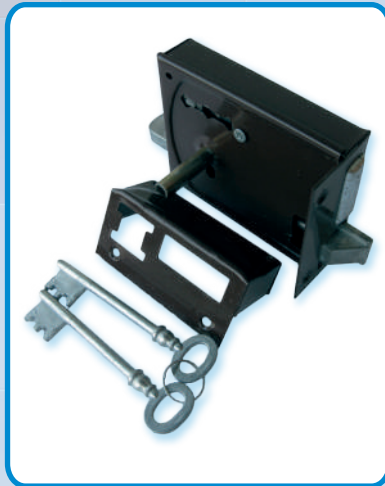

**Fechadura**

**Ref. 101 / 102**

Tamanhos: 10/12/14

Fechadura	Preço	Tamanho
101	5,84€	10/12/14
102	5,63€	10/12/14

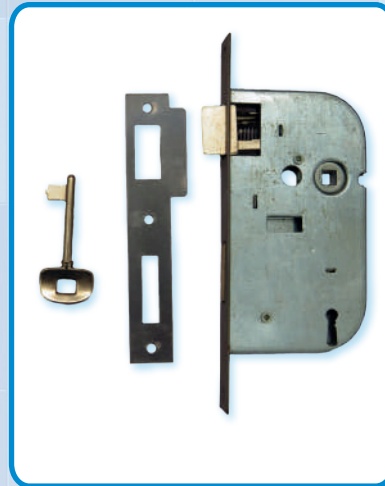

**Fechadura "Inferlar"**

**Ref. 716**

Testa Curta / Comprida

Tamanho: 55/65

Cor	Preço
Inox Mate	7,23€
Ferro Bronze	6,34€

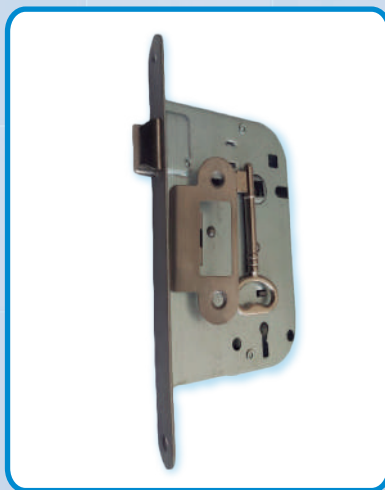

**Fechadura 716**

**Ref. Só Trinque**

Tamanho: 60

Cor	Preço
Inox Mate	3,27€
Latão Bronze	4,02€
Latão Polido	4,15€
Ferro Lacado	3,16€

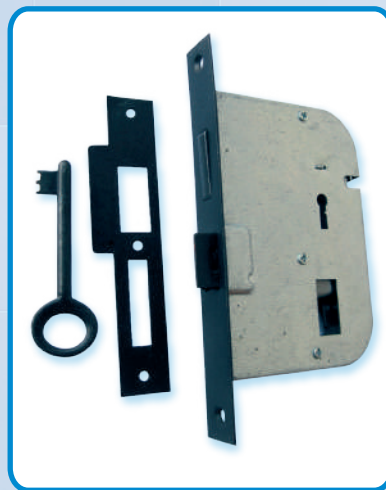

**Fechadura Trinqueta**

**Ref. 718**

Testa Redonda / Quadrada

Tamanho: 55/60/65

Cor	Preço
Inox Mate	6,41€
Latão Bronze	6,73€
Latão Polido	6,80€
Ferro / Bronze	6,11€
Ferro Lacado	6,34€



**Fechadura com Embalamento Skin**

(Preço Sob Consulta)



ESQUADRO P/ CALHA ALUMÍNIO (INTERIOR)	0,06€
---------------------------------------	-------



ESQUADRO 2 FUROS	0,04€
------------------	-------

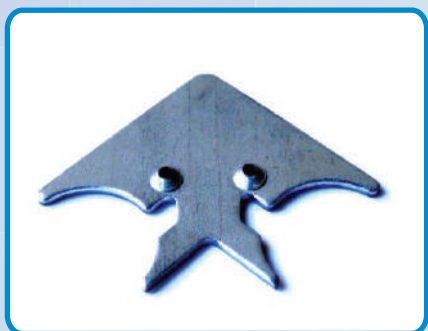

ESQUADRO P/ CALHA ALUMÍNIO C/ ROSCA	0,51€
ESQUADRO P/ CALHA ALUMÍNIO S/ ROSCA	0,38€



ESQUADRO 4 FUROS	0,06€
------------------	-------



FERRO QUADRADO #6	0,26€
FERRO QUADRADO #8	0,32€



CASQUILHO PARA REDUÇÃO	0,14€
------------------------	-------



Ref. 1003

Cor	Preço
Inox Mate (Inox 304)	7,76€
Latão Bronze	8,27€
Latão Polido	8,53€
Inox Mate (Inox 430)	6,98€
Ferro Lacado	6,84€



Ref. 1004



## Cremone Ref. Punho

Cor	Preço
Inox Mate	9,27€
Latão Bronze	9,86€
Latão Polido	9,99€
Lacado	9,31€



Vareta p/ cremone em chapa

Cor	Preço
Inox Mate	1,60€
Ferro Bronze	1,41€
Latão Bronze	3,25€
Latão Polido	3,40€

(Preço por Metro)



Passadeiras  
para cremones

Cor	Preço
Inox Mate(Inox 430)	0,22€
Inox Mate(Inox 304)	0,44€
Latão Bronze	0,60€
Latão Polido	0,63€
Lacado	0,45€

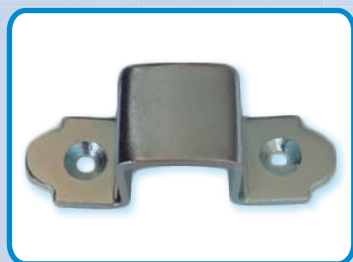

## Grampas para fechos de rebate

Cor	Tamanhos / Peças		
	3/8	4/8	5/16
Ferro Bronze	0,53€	0,58€	0,45€
Lacado	0,71€	0,76€	0,56€
Zincado	0,47€	0,52€	0,44€
Latão Bronze	1,42€	1,48€	1,17€
Latão Niquel	1,47€	1,53€	1,22€



## Fechos de Rebate

Ref. 177

Tamanhos: 5/16 (8mm)

Cor	Tamanhos / Peças		
	1/2P	3/4	1P
Ferro Zincado	1,82€	1,98€	2,09€
Ferro Bronze	3,08€	4,65€	5,29€
Latão Bro/Pol	8,80€	9,48€	10,05€
Latão Niquel	9,10€	9,79€	10,40€
Ferro Lacado	2,19€	2,72€	3,02€

Outras medidas, preços sob consulta.

## Fechos de Rebate

Ref. 177

Tamanhos: 3/8 (10mm)

Cor	Tamanhos / Peças				
	1/2P	3/4	1P	1 1/2P	2P
Ferro Zincado	1,98€	2,21€	2,59€	3,27€	4,03€
Ferro Bronze	3,73€	4,41€	4,82€	6,08€	8,22€
Latão Bro/Pol	10,68€	11,40€	12,47€	15,50€	19,75€
Latão Niquel	10,90€	11,70€	12,72€	15,95€	20,25€
Ferro Lacado	2,56€	2,81€	3,03€	3,42€	4,41€

Outras medidas, preços sob consulta.

## Fechos de Rebate

Ref. 177

Tamanhos: 4/8 (12mm)

Cor	Tamanhos / Peças				
	1/2P	3/4	1P	1 1/2P	2P
Ferro Zincado	3,20€	3,40€	3,73€	4,53€	5,30€
Ferro Bronze	5,80€	5,98€	7,63€	9,37€	10,10€
Latão Bro/Pol	14,70€	15,00€	16,60€	21,99€	26,50€
Latão Niquel	15,01€	15,35€	16,98€	22,40€	27,20€
Ferro Lacado	3,81€	2,81€	3,03€	3,42€	4,41€

Outras medidas, preços sob consulta.



## Fechos

**Ref. 207**

Normal / Ponta Virada

Tamanhos: 1/2p/3-4/1P

Cor	Tamanhos / Preços				
	1/2P	3/4	1P	1 1/2P	2P
Inox Mate	2,11€	2,34€	2,51€	4,45€	5,53€
Latão Bronze	3,05€	3,26€	3,59€	9,78€	11,35€
Latão Polido	3,15€	3,36€	3,74€	9,90€	11,60€
Ferro Lacado	2,11€	2,31€	2,61€	5,31€	6,77€
Ferro Bronze	2,02€	2,09€	2,24€	4,90€	6,33€

Outras medidas, preços sob consulta.

## Ficha técnica

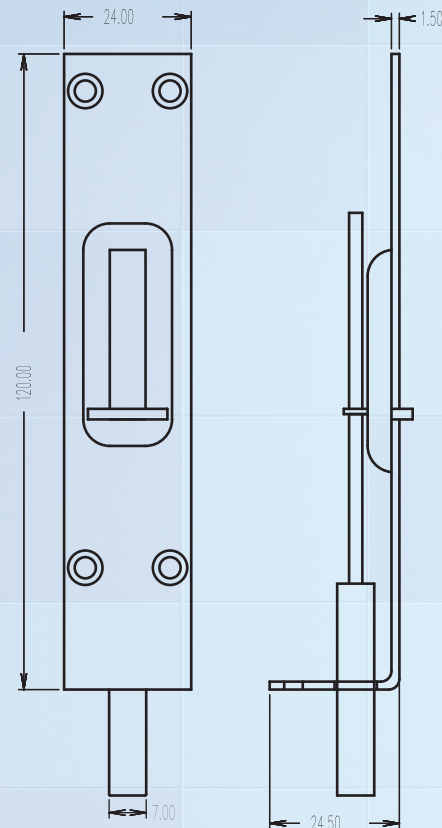

## Fechos

**Ref. 401**

Tamanhos: 160 / 200 / 250

Cor	Tamanhos / Preços		
	160	200	250
Inox Mate	2,13€	2,30€	2,60€
Latão Bronze	2,88€	3,17€	3,35€
Latão Polido	2,99€	3,30€	3,50€
Ferro Bronze	2,05€	2,14€	2,38€
Ferro Lacado	2,18€	2,31€	2,51€

## Ficha técnica

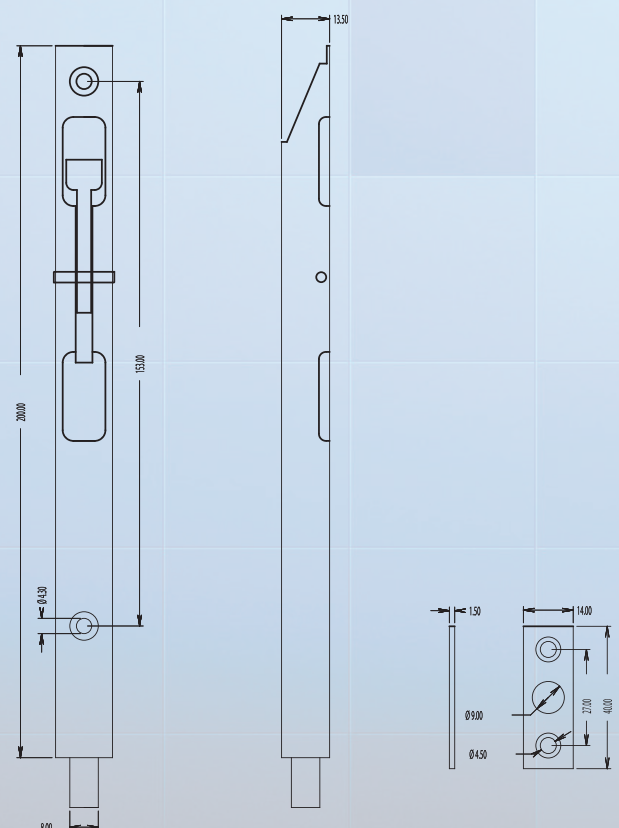





## Suporte de Corrimão

Cor	Preço
Mate	3,68€
Latão Bronze	4,28€
Latão Polido	4,36€
Ferro Lacado	2,61€



## Espelho Redondo

Ref. 725

Redondo para fechaduras

Cor	Preço
Inox Mate	0,35€
Ferro Bronze	0,35€



## Cilindro

Ref.

Tamanhos: 60

Cor	Preço
Latão Polido	3,20€
Latão Niquelado	3,00€

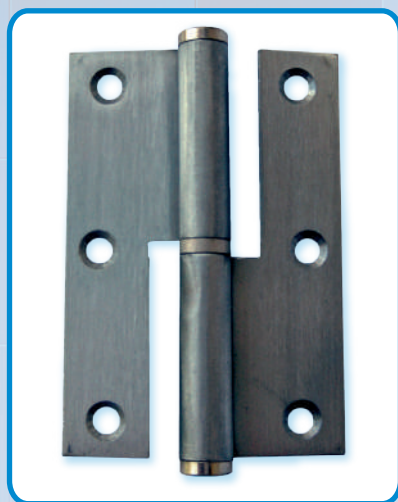

**Dobradiça Inox Mate**

Ref. Balanço e Leme

Tamanhos: 2.5 / 3 / 3.5

Referência / Cor	2.5	3	3.5
Ferro Bronze, 1/2 Balanço e Leme	0,91€	0,96€	1,02€
Ferro Bronze, 1/2 Balanço Redondo, Leme e Balanço	0,93€	1,00€	1,21€



**Chumbadouro N°57**

ZINCADO

Tamanho	11/2	13/4	2	21/4	21/2	23/4	3	31/2
Preço	1,21€	1,23€	1,28€	1,43€	1,43€	1,52€	1,83€	2,18€



**Chumbadouro N°59**

ZINCADO

Tamanho	2	21/4	21/2	23/4	3
Preço	1,17€	1,22€	1,29€	1,34€	1,42€



**Chumbadouro N°62**

FERRO POLIDO

Tamanho	2	21/4	21/2	23/4	3	31/2
Preço	1,15€	1,19€	1,31€	1,50€	1,56€	1,78€
Zincado	1,21€	1,27€	1,39€	1,58€	1,66€	1,88€



**Chumbadouro N°61**

FERRO POLIDO

Tamanho	13/4	2	21/4	21/2	23/4	3	31/2
Preço	1,58€	1,71€	1,77€	2,04€	2,14€	2,37€	2,94€
Zincado	1,68€	1,81€	1,87€	2,15€	2,27€	2,50€	3,09€



**Chumbadouro N°61**

RABO DE PEDRA (LACADO)

Tamanho	13/4	2	21/4	21/2	23/4	3	31/2
Preço	2,28€	2,43€	2,50€	2,80€	2,93€	3,14€	3,72€



Abraçadeira  
c/ Espigão simples  
p/ tubo de Cobre



Abraçadeira  
c/ Espigão dupla  
p/ tubo de Cobre

Aperto em mm	Simples (Unid.)	Duplos (Unid.)
10-12	0,28€	0,32€
14-16	0,29€	0,33€
18-20	0,30€	0,34€
22-24	0,33€	0,37€
26-28	0,35€	0,39€



Abraçadeira p/ Inox  
Simples/Dupla

Medida	Simples (Unid.)	Duplo (Unid.)
15	0,37€	0,40€
18	0,43€	0,47€
22	0,54€	0,59€

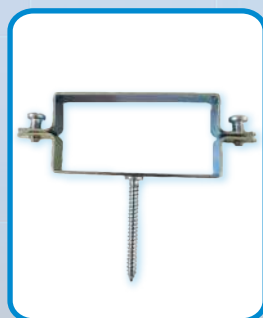

Abraçadeira  
Retangular

Medida	Zincado	Inox	Lacado
80x40	0.32€	1,13€	0,95€
100x50	0.42€	1,33€	1,20€
120x60	0.58€	1,44€	1,29€
80x60	0.48€	1,35€	



Abraçadeira  
com Espigão

Medida	Aperto em mm	Preço (Unid.) ZINCADO	Preço (Unid.) INOX	Embalagem
1/2"	20	0,17€	0,71€	100 Peças
3/4"	25	0,17€	0,72€	
1"	32	0,19€	0,74€	
1" 1/4	40	0,21€	0,82€	
1" 1/2	50	0,22€	0,93€	
2"	63	0,27€	0,99€	
2" 1/2	75	0,33€	1,09€	50 Peças
3"	90	0,37€	1,16€	
4"	110	0,41€	1,24€	
5"	125	0,45€	1,35€	
6"	140	0,59€	1,49€	
-	150	0,73€	1,80€	
-	160	0,79€	1,95€	
-	180	0,88€	2,06€	
-	200	1,10€	2,22€	



Abraçadeira  
com porca M8

Medida	Aperto em mm	Preço (Unid.) ZINCADO	Preço (Unid.) INOX	Embalagem
1/2"	20	0,26€	0,75€	100 Peças
3/4"	25	0,27€	0,77€	
1"	32	0,28€	0,80€	
1" 1/4	40	0,31€	0,85€	
1" 1/2	50	0,33€	0,92€	
2"	63	0,37€	1,03€	
2" 1/2	75	0,42€	1,10€	50 Peças
3"	90	0,45€	1,18€	
4"	110	0,52€	1,27€	
5"	125	0,58€	1,35€	
6"	140	0,63€	1,45€	



Abraçadeira  
Hercules Inox  
Abraçadeira  
Hercules Zincado

Medida	Aperto em mm	Preço (Un.) ZINCADO	Preço (Unid.) INOX	Embalagem
3/4"	24-32	0,54€	1,19€	50 Peças
1"	33-40	0,55€	1,21€	
1" 1/4	39-45	0,56€	1,25€	
1" 1/2	48-58	0,57€	1,34€	
2"	60-70	0,58€	1,39€	
68-75	68-75	0,60€	1,41€	
2" 1/2	71-80	0,62€	1,45€	
3"	89-97	0,65€	1,50€	
98-105	98-105	0,67€	1,58€	
4"	107-116	0,69€	1,59€	
5"	137-146	0,70€	1,66€	

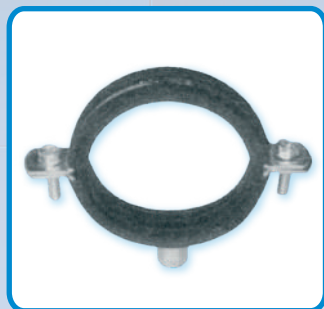

**Abraçadeira  
Reforçada M8 + M10  
c/ Borracha**

Medida	Aperto em mm	Polegadas	Preço (Unid.)	Embalagem
20-25	Ø 22	1/2"	0,64€	100 Peças
26-30	Ø 28	3/4"	0,67€	
32-36	Ø 35	1"	0,70€	
38-45	Ø 40	1" 1/4	0,74€	
47-51	Ø 48	1" 1/2	0,77€	
53-58	Ø 54		0,83€	
60-64	Ø 60	2"	0,85€	50 Peças
68-72	Ø 70		0,89€	
74-80	Ø 75	2" 1/2	0,91€	
81-86	Ø 83		0,95€	
87-92	Ø 90	3"	0,99€	25 Peças
99-105	Ø 100		1,06€	
107-112	Ø 110	4"	1,13€	
113-118	Ø 115		1,21€	
125-130	Ø 125	5"	1,28€	
131-137	Ø 133		1,31€	
138-142	Ø 140	6"	1,35€	
148-152	Ø 150		1,41€	
159-166	Ø 160		1,49€	
178-184	Ø 180		1,60€	
200-205	Ø 200		1,82€	
215-220	Ø 220		2,23€	
223-228	Ø 225		2,47€	
249-254	Ø 250		2,74€	
279-284	Ø 280		2,88€	
299-304	Ø 300		2,93€	
314-319	Ø 315		3,13€	
354-359	Ø 350		3,73€	

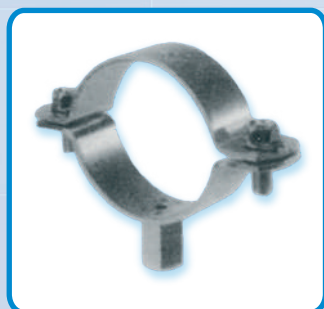

**Abraçadeira  
Reforçada M8 + M10**

Medida	Aperto em mm	Polegadas	Preço (Unid.)	Embalagem
15-19	Ø 18	3/8"	0,52€	100 Peças
20-25	Ø 22	1/2"	0,53€	
26-30	Ø 28	3/4"	0,54€	
32-36	Ø 35	1"	0,55€	
38-45	Ø 40	1" 1/4	0,58€	
47-51	Ø 48	1" 1/2	0,59€	
53-58	Ø 54		0,60€	50 Peças
60-64	Ø 60	2"	0,63€	
74-80	Ø 75	2" 1/2	0,64€	
87-92	Ø 90	3"	0,67€	
99-105	Ø 100		0,69€	25 Peças
107-112	Ø 110	4"	0,71€	
113-118	Ø 115		0,74€	
125-130	Ø 125	5"	0,76€	
138-142	Ø 140	6"	0,79€	
148-152	Ø 150		0,83€	
159-166	Ø 160		0,91€	
179-184	Ø 180		1,00€	
200-205	Ø 200		1,11€	
215-220	Ø 220		1,58€	
223-228	Ø 225		1,65€	
249-254	Ø 250		1,84€	
279-284	Ø 280		2,28€	
299-304	Ø 300		2,38€	
314-319	Ø 315		2,63€	
354-359	Ø 350		2,83€	



Abraçadeira  
GÁS

Medida	Preço (Unid.)
6-8	0,13€
7-9	0,13€
8-10	0,13€
9-11	0,13€
12-14	0,13€
13-15	0,14€
15-17	0,14€
16-18	0,15€
17-19	0,16€
18-20	0,17€
20-22	0,18€



Abraçadeira  
GÁS (Galp)

Medida	Preço (Unid.)
16-18	0,21€
18-20	0,22€
20-22	0,23€



Kit Tipo Fixação  
Vertical / Multifuros

Medida	ZINCADO
	Preço (Unid.)
2 Parafusos M6X70	1,10€
Multifuros	2,80€



Abraçadeira fixação "L"

Preço
0,15€

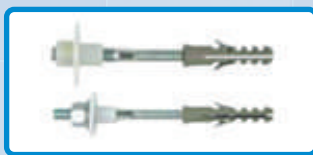

Kit Fixação Lavatório

Medida	INOX	ZINCADO
	Preço (Unid.)	Preço (Unid.)
2 Parafusos M8X110	2,20€	0,66€



Abraçadeira fixação "U"

Preço
0,15€



Kit Fixação Sanita e Bidé

Medida	INOX	ZINCADO
	Preço (Unid.)	Preço (Unid.)
2 Parafusos M6X70	0,95€	0,38€
4 Parafusos M5X70	1,80€	0,74€



Suportes de  
Caleira

Ref.	Preço (Unid.)
Caleira 102	0,88€
Caleira 125	1,01€
Caleira 150	1,07€



Suportes  
de Telha

Ref.	Preço (Unid.)
Caleira 102	1,00€
Caleira 125	1,06€
Caleira 150	1,15€
Caleira 60x100	1,14€

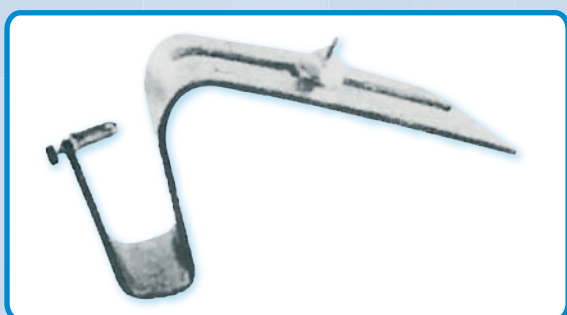

Peça de Telha  
Lusofane

Ref.	Preço (Unid.)
Telha Zincada	0,56€
Telha Inox	1,50€

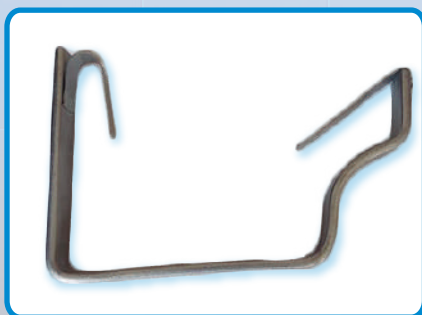

Suporte de Telha/  
Suporte Caleira  
"Covilhã"

Ref.	Acabamento	Preço (Unid.)
Suporte Telha	Zincado	1,04€
Suporte Caleira	Zincado	1,04€
Suporte Telha	Lacado	1,68€
Suporte Caleira	Lacado	1,68€

**Abraçadeira Sem Fim 9MM**

		W1	W2	W4
Medida	Aperto em mm	Preço (Unid.)	Preço (Unid.)	Preço (Unid.)
	8-12	0,12€	0,16€	0,37€
3/16"	10-16	0,12€	0,16€	0,37€
3/8"	12-22	0,14€	0,17€	0,38€
1/2"	16-27	0,14€	0,17€	0,40€
3/4"	20-32	0,15€	0,20€	0,46€
1"	25-40	0,16€	0,20€	0,49€
1" 1/4	30-45	0,17€	0,22€	0,50€
1" 1/2	32-50	0,17€	0,23€	0,52€
1 3/4"	40-60	0,20€	0,24€	0,58€
2"	50-70	0,22€	0,27€	0,60€
2" 1/2	60-80	0,23€	0,29€	0,63€
3"	70-90	0,24€	0,30€	0,66€
	80-100	0,24€	0,31€	0,70€
4"	90-110	0,24€	0,32€	0,73€
	100-120	0,25€	0,34€	0,78€
5"	110-130	0,27€	0,35€	0,79€
	120-140	0,28€	0,38€	0,86€

**Abraçadeira Sem Fim 12MM**

		W1	W2	W4
Medida	Aperto em mm	Preço (Unid.)	Preço (Unid.)	Preço (Unid.)
1/2"	16-27	0,16€	0,22€	0,53€
3/4"	20-32	0,18€	0,25€	0,56€
7/8"	23-35	0,18€	0,25€	0,57€
1"	25-40	0,19€	0,26€	0,62€
1" 1/4	30-45	0,20€	0,27€	0,65€
1" 1/2	32-50	0,21€	0,29€	0,67€
1" 3/4	40-60	0,24€	0,31€	0,73€
2"	50-70	0,26€	0,34€	0,77€
2" 1/2	60-80	0,28€	0,36€	0,86€
3"	70-90	0,29€	0,38€	0,92€
	80-100	0,33€	0,39€	0,97€
4"	90-110	0,35€	0,40€	1,00€
	100-120	0,37€	0,43€	1,08€
5"	110-130	0,39€	0,44€	1,13€
	120-140	0,42€	0,48€	1,15€
6"	130-150	0,44€	0,50€	1,25€